



# 17 ALUPROFILO

Profilo in Alluminio per vetro strutturale

Profilo in Alluminio effetto acciaio inox per pannelli in vetro con spessori da 12,76mm a 21,52mm.

1. Fissaggio a Pavimento
2. Fissaggio laterale

**Calcolo Statico eseguito con risultato positivo per Spinta di: 2,00 KN/ml**

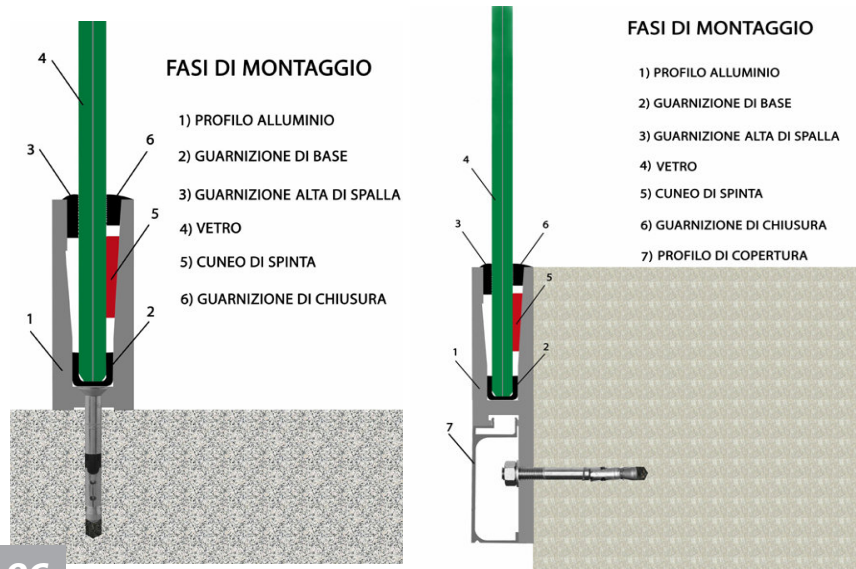

Possibilità di abbinare il MANCORRENTE SUPERIORE SCANALATO. (Vedi Capitolo 16)

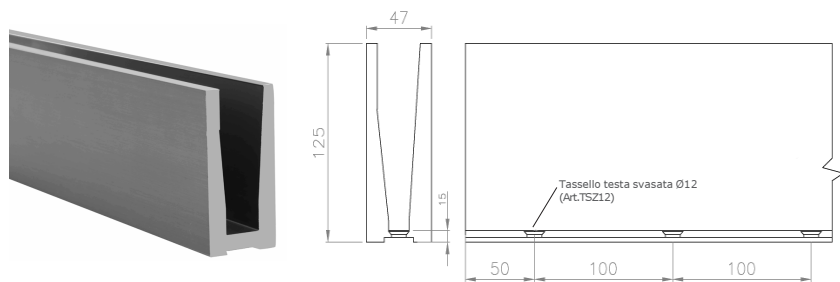

**ALU**PROFILO** a Pavimento**

Art. Nr.	L	Materiale
ALU13000	3000 mm	Alluminio effetto inox

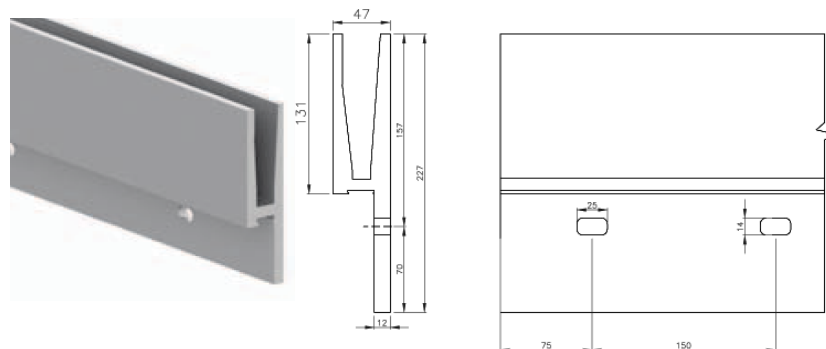
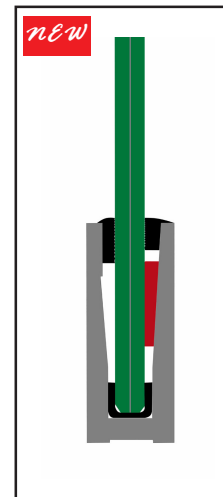

**ALU**PROFILO** laterale**

Art. Nr.	L	Materiale
ALU33000	3000 mm	Alluminio effetto inox

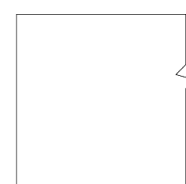
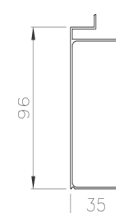
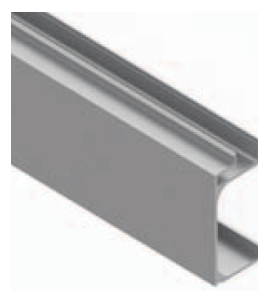

**Copertura per ALU**PROFILO** laterale**

Art. Nr.	L	Materiale
ALU43000	3000 mm	Alluminio effetto inox

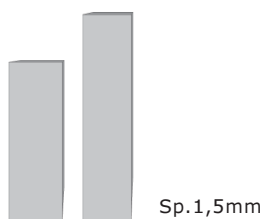

**Lamiera di chiusura**

Art. Nr.	LxH	Usare con	Materiale
ALU5	47x125mm	ALU13000	Alluminio effetto inox
ALU6	47x228mm	ALU33000	Alluminio effetto inox

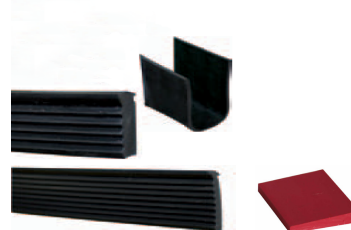

**Set guarnizioni in gomma e cunei di spinta**

Art. Nr.	Spessore vetro	L
ALUSET13000	12,76-13,52mm	3000mm
ALUSET23000	16,76-17,52 mm	3000mm
ALUSET33000	20,76-21,52mm	3000mm

