



16 SISTEMA VETRO CON TUBO SCANALATO

- RACCORDI PER TUBO SCANALATO
- TUBO SCANALATO Ø42,4x1,5mm
- GUARNIZIONE IN EPDM

Sistema di chiusura con Profilo scanalato a U per parapetti con vetro di grosso spessore, fino a Max **21,52mm** [10-1,52-10]

Il risultato sarà di notevole impatto estetico, senza rinunce alla praticità, all'efficienza e alla resistenza.

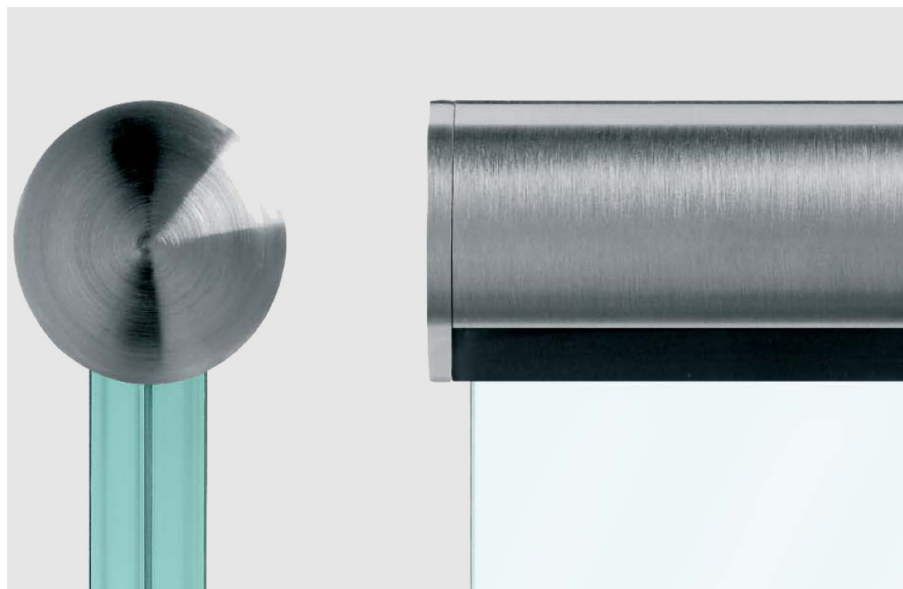

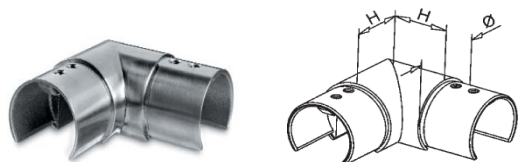

Gomito 90° scanalato (Orizz.)

Art. Nr.	Ø	H	Materiale
173D42	42,4x1,5	30	Aisi 304
173D426	42,4x1,5	30	Aisi 316

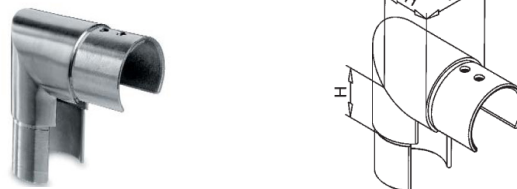

Gomito 90° scanalato (Vert.)

Art. Nr.	Ø	H	Materiale
174D42	42,4x1,5	30	Aisi 304
174D426	42,4x1,5	30	Aisi 316



Snodo scanalato 25-55° in basso

Art. Nr.	Ø	H	Materiale
176D42	42,4x1,5	30	Aisi 304

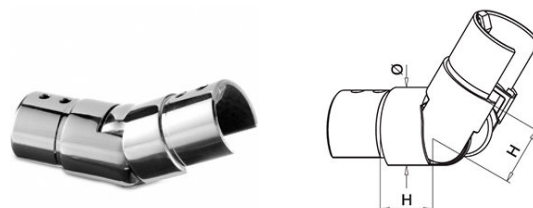

Snodo scanalato 25-55° in alto

Art. Nr.	Ø	H	Materiale
177D42	42,4x1,5	30	Aisi 304

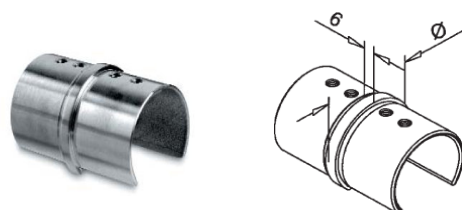

Giunto scanalato

Art. Nr.	Ø	Materiale
285D42	42,4x1,5	Aisi 304
285D426	42,4x1,5	Aisi 316

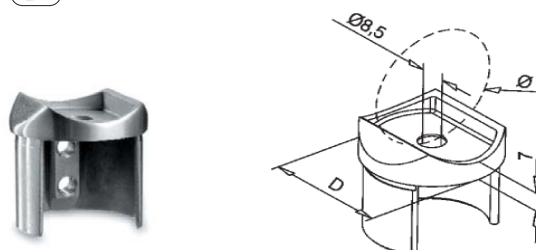

Sella scanalata

Art. Nr.	Ø	D	Materiale
159D42	42,4	42,4x1,5	Aisi 304
159D426	42,4	42,4x1,5	Aisi 316

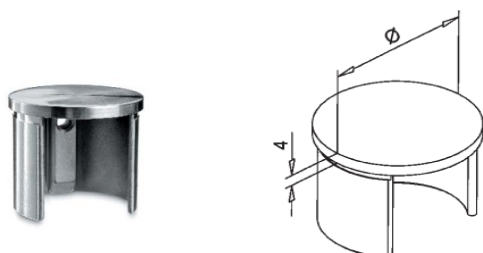

Calotta scanalata piatta

Art. Nr.	Ø	Materiale
158D42	42,4x1,5	Aisi 304
158D426	42,4x1,5	Aisi 316

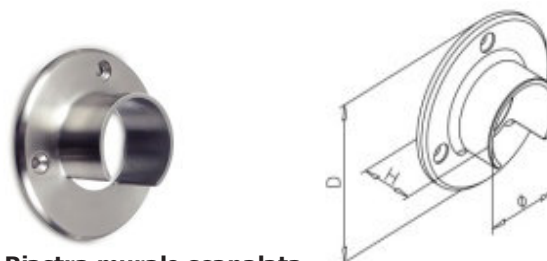

Piastra murale scanalata

Art. Nr.	Ø	D	H	Materiale
175D42	42,4	90	30	Aisi 304
175D426	42,4	90	30	Aisi 316



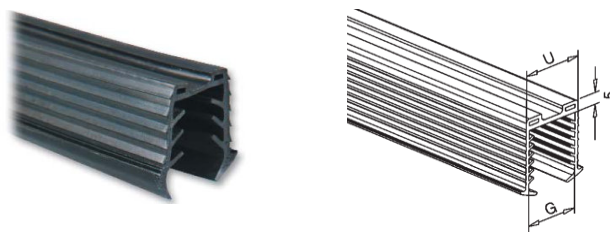
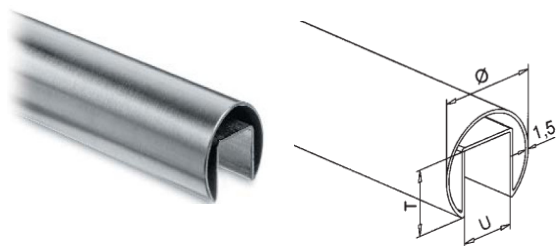

Tubo Scanalato U per vetro

Art.Nr.	Ø	U	T	L	Materiale
TU04224SC	42,4x1,5	24	24	6000 mm	Aisi 304
TU042246SC	42,4x1,5	24	24	6000 mm	Aisi 316

Guarnizione in gomma EPDM nera per tubo scanalato

Art. Nr.	Ø	U	G	L
GOMMA813	42,4	24	8-12mm	su misura
GOMMA1418	42,4	24	12,76-17,52mm	su misura
GOMMA2022	42,4	24	20-21,52mm	su misura

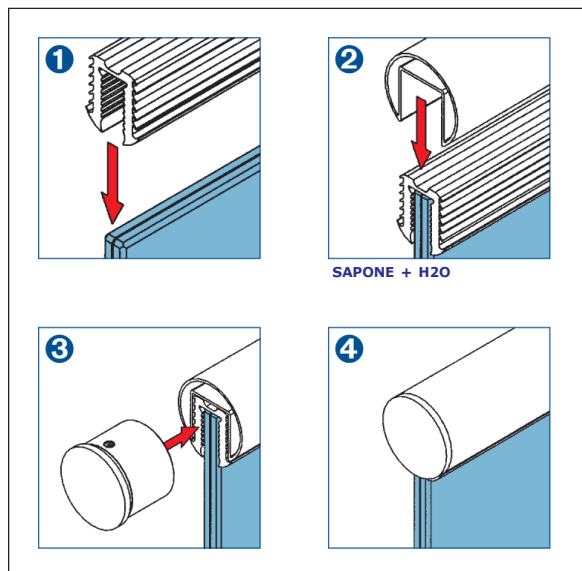

NB: Prima di alloggiare il tubo scanalato sulla guarnizione, come si vede al **Punto 2**, è consigliabile cospargere con acqua e sapone la gomma stessa per agevolare l'innesto del tubolare scanalato.

